



DESCRIPTION

VA7483

24V electromotive proportional actuator (signal 0-10V) with feedback and valve stroke detection system. Max stroke 6,3mm.

Suitable for all axial Pettinaroli PICV (**91**, **92** and **93**); Connection M30x1,5 adapted to Pettinaroli standards through specific adaptors.

Suitable also for 2-way, 3-way and 4-way control valve **662**, **663** and **664** (without extra adaptors). Not suitable for 91 manufactured before 2019 (see date code on PICV).

DIMENSIONS

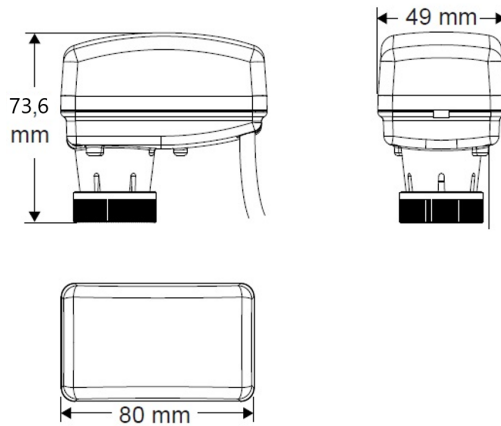

TECHNICAL FEATURES

Type	Proportional	Max fluid temperature	95°C
Supply voltage	24V AC/DC ±15% 50/60 Hz	Max storage temperature	-20° / + 65°C (@)
Power consumption	2,5 VA / 1,5 W	Max ambient temperature	0° / + 50° C (@)
Control signal	0(2)-10V DC – 0(4)-20mA	Degree of protection	IP43/III
Feedback	0-10V DC	Weight	200 g
Max stroke	6,3 mm	Colour	White
Running time	8 sec/mm	Connection cable	4 x 0.35 mm ²
Actuating force	160 N	Cable lenght	2 m
Input impedance (voltage control)	> 100 kΩ	Noise level	<30 dB(A)
Input impedance (current control)	500 Ω	Adaptor/ring	0A7010 0A748X

(@) non condensing

The 24V electromotive actuator VA7483 is widely employed to drive in proportional mode pressure independent control valves EVOPICV controlling heating and cooling systems by means of BMS (Building Management System) or suitable room thermostat (managing and generating proportional signal 0-10V). Electrical connection is discussed in the following section. In order to choose the right actuator and properly install it, follow the scheme below:

- **91**, **92 ½"** and **92 ¾"** with adaptor **0A7010** (not included, to order separately)
- **93**, **92 1"** and **92 1 ¼"** with adaptor **0A748X** (not included, to order separately)

APPROVALS



ELECTRICAL CONNECTIONS

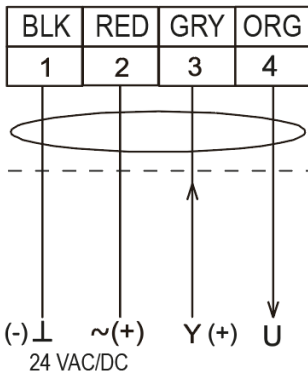

OPERATING STATUS INDICATOR

The VA7483–24V (0-10V) electromotive actuator has a double colour LED (green/red) indicating its operating status as shown by the table below:

OFF		No power supply
Green blinking		Moving to position
Green steady on		Position reached
Red blinking		Calibration cycle
Red fast blinking		Valve stem closing failure
Red steady on		4-20mA or 2-10VDC lost

INSTALLATION

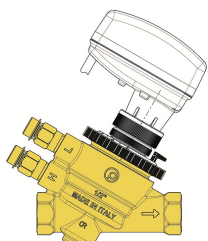

Fig. 1

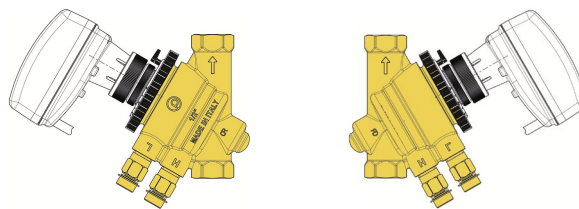

Fig. 2

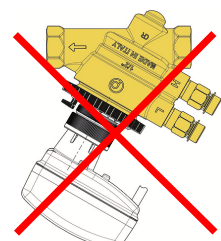
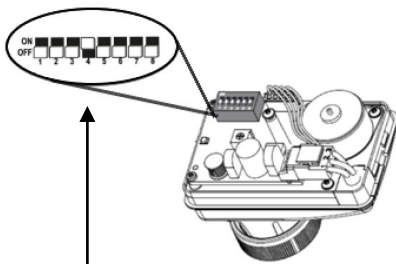

Fig. 3

- For electrical safety reasons the VA7483 electromotive actuator has to be installed as shown by pictures 1 and 2. The upside down installation shown in picture 3 must be avoided. Always install the actuator with the pin in fully retracted position;
- Do not power the actuator if not installed on the valve;
- Tighten the connecting ring by hand only. Do not use any tools;
- Keep a clear space of 15 cm over the actuator to access it, if required.

SETTING

DIP SWITCH 1-2-3-6



Default configuration

OPTIONS DIP SWITCH			
<input type="checkbox"/> 0-10 VDC	<input type="checkbox"/> 0-20 mA	<input type="checkbox"/> 5-10 VDC	<input type="checkbox"/> 2-10 VDC
<input type="checkbox"/> 0-5 VDC	<input type="checkbox"/> 4-20 mA	<input type="checkbox"/> DA	<input type="checkbox"/> RA
<input type="checkbox"/> LIN	<input type="checkbox"/> Eq%	<input type="checkbox"/> VDC	<input type="checkbox"/> mA
<input type="checkbox"/> NOT USED	<input type="checkbox"/> NOT USED	<input type="checkbox"/> NOT USED	<input type="checkbox"/> NOT USED
<input type="checkbox"/> NOT USED	<input type="checkbox"/> NOT USED	<input type="checkbox"/> NOT USED	<input type="checkbox"/> NOT USED
1: CONTROL SIGNAL RANGE	5: CURVE	6: SIGNAL TYPE	
2: CONTROL SIGNAL RANGE	7: NOT USED		
3: ACTION	8: NOT USED		

The VA7483–24V (0-10V) electromotive proportional actuator has 8 switch ON/OFF which allow the actuator set-up according to operation request.

The control signal (voltage V DC or current mA) is set through switch n° 1-2-3.

The control signal type is selected by switch n°6.

The default position of switches n°1-2-3-6 is OFF.

DIP SWITCH 4

The switch n. 4 allows the user to change the actuator action according to digital input:

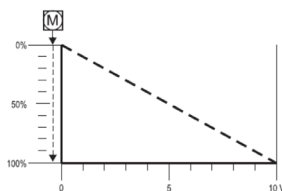

Switch n°4 – OFF: Direct action – When the signal increases, the valve closes. 0 V valve open, 10 V valve closed.

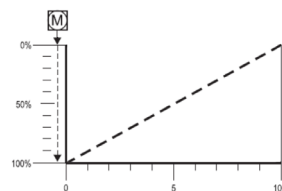

Switch n°4 – ON (default): Reverse action – When the signal increases, the valve opens. 0 V valve closed, 10 V valve open.

DIP SWITCH 5

The switch n°5 sets the actuator control characteristic in order to get a LINEAR response (switch n°5 – OFF - default) or EQUAL PERCENTAGE one (switch n°5 - ON) of the actuator. In default switch n°5 is set to OFF.